

PARAFANGO ZINCO GOMMA (Z/G)

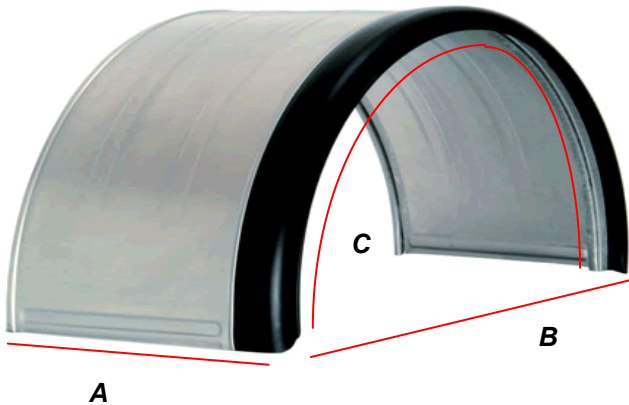

| CODICE | A | B | C |
|----------------|-----|------|------|
| SA10.ZG0001.00 | 220 | 800 | 1300 |
| SA10.ZG0002.00 | 240 | 880 | 1350 |
| SA10.ZG0003.00 | 280 | 880 | 1300 |
| SA10.ZG0004.00 | 280 | 1000 | 1500 |
| SA10.ZG0005.00 | 400 | 880 | 1360 |
| SA10.ZG0006.00 | 425 | 1000 | 1500 |
| SA10.ZG0007.00 | 450 | 880 | 1360 |
| SA10.ZG0008.00 | 450 | 1000 | 1500 |
| SA10.ZG0009.00 | 450 | 1340 | 2100 |
| SA10.ZG0011.00 | 475 | 1000 | 1600 |
| SA10.ZG0012.00 | 500 | 1000 | 1500 |
| SA10.ZG0013.00 | 500 | 1000 | 1650 |
| SA10.ZG0014.00 | 500 | 1120 | 1750 |
| SA10.ZG0016.00 | 550 | 1000 | 1650 |
| SA10.ZG0017.00 | 550 | 1110 | 1750 |
| SA10.ZG0018.00 | 550 | 1200 | 1850 |
| SA10.ZG0019.00 | 550 | 1260 | 2000 |
| SA10.ZG0021.00 | 600 | 1115 | 1800 |
| SA10.ZG0022.00 | 600 | 1115 | 1700 |
| SA10.ZG0023.00 | 600 | 1200 | 1900 |
| SA10.ZG0024.00 | 600 | 1200 | 2000 |
| SA10.ZG0024.01 | 600 | 1340 | 2100 |
| SA10.ZG0029.00 | 650 | 1115 | 1800 |
| SA10.ZG0030.00 | 650 | 1200 | 1900 |
| SA10.ZG0031.00 | 650 | 1250 | 2000 |
| SA10.ZG0032.00 | 650 | 1340 | 2100 |
| SA10.ZG0033.00 | 650 | 1400 | 2300 |

PARAFANGO 3 ASSI ZINCO GOMMA (Z/G)

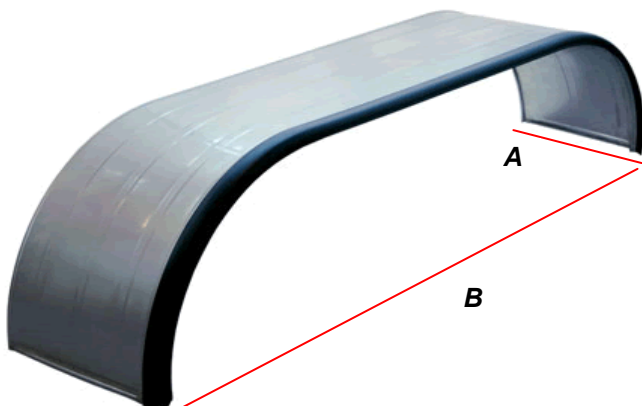

| CODICE | A | B | C |
|----------------|-----|------|------|
| SA10.ZG0010.00 | 450 | 4100 | 4900 |
| SA10.ZG0015.00 | 500 | 4100 | 4900 |
| SA10.ZG0020.00 | 550 | 2550 | 3300 |
| SA10.ZG0020.01 | 550 | 4100 | 4900 |
| SA10.ZG0025.00 | 600 | 2500 | 3200 |
| SA10.ZG0026.00 | 600 | 2640 | 3400 |
| SA10.ZG0027.00 | 600 | 2740 | 3500 |
| SA10.ZG0028.00 | 600 | 4100 | 4900 |
| SA10.ZG0034.00 | 650 | 2640 | 3400 |
| SA10.ZG0035.00 | 650 | 2740 | 3500 |
| SA10.ZG0036.00 | 650 | 4100 | 4900 |

MEZZO PARAFANGO ZINCO GOMMA (Z/G)

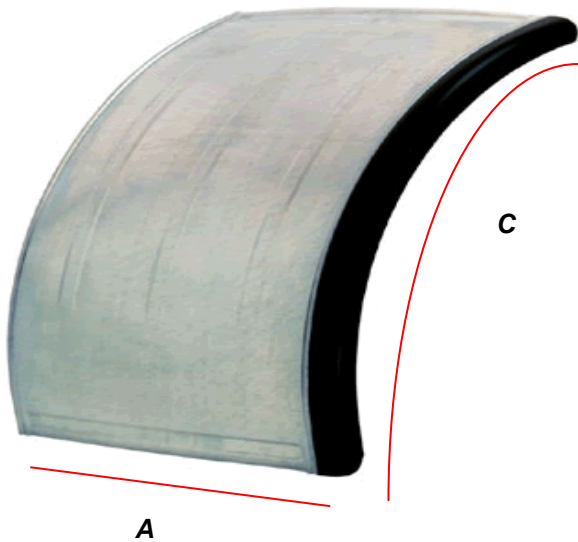

| CODICE | A | B |
|----------------|----------|----------|
| SA10.ZG0036.01 | 400 | 600 |
| SA10.ZG0037.00 | 450 | 600 |
| SA10.ZG0038.00 | 450 | 700 |
| SA10.ZG0039.00 | 450 | 800 |
| SA10.ZG0040.00 | 450 | 1000 |
| SA10.ZG0041.00 | 500 | 500 |
| SA10.ZG0041.01 | 500 | 550 |
| SA10.ZG0042.00 | 500 | 600 |
| SA10.ZG0043.00 | 500 | 700 |
| SA10.ZG0044.00 | 500 | 800 |
| SA10.ZG0045.00 | 500 | 900 |
| SA10.ZG0046.00 | 500 | 1000 |
| SA10.ZG0047.00 | 550 | 700 |
| SA10.ZG0048.00 | 550 | 800 |
| SA10.ZG0049.00 | 550 | 1000 |
| SA10.ZG0050.00 | 600 | 600 |
| SA10.ZG0051.00 | 600 | 700 |
| SA10.ZG0052.00 | 600 | 800 |
| SA10.ZG0053.00 | 600 | 900 |
| SA10.ZG0054.00 | 600 | 1000 |
| SA10.ZG0055.00 | 600 | 1200 |
| SA10.ZG0056.00 | 650 | 650 |
| SA10.ZG0057.00 | 650 | 700 |
| SA10.ZG0058.00 | 650 | 800 |
| SA10.ZG0059.00 | 650 | 1000 |
| SA10.ZG0060.00 | 650 | 1100 |
| SA10.ZG0061.00 | 650 | 1200 |

PARAFANGO BORDO GOMMA INOX (BGI)

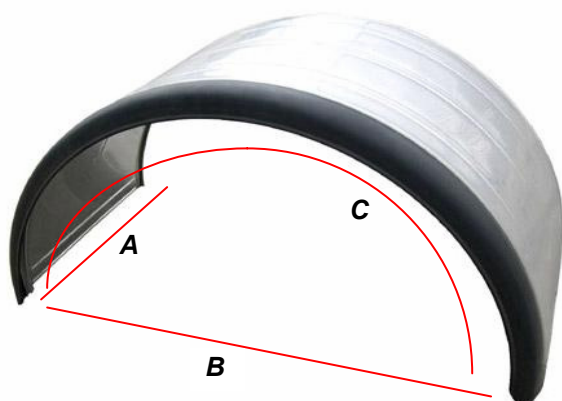

| CODICE | A | B | C |
|-----------------|-----|------|------|
| SA10.BGI0001.00 | 220 | 800 | 1250 |
| SA10.BGI0002.00 | 240 | 900 | 1360 |
| SA10.BGI0003.00 | 280 | 880 | 1360 |
| SA10.BGI0004.00 | 400 | 880 | 1360 |
| SA10.BGI0005.00 | 425 | 1000 | 1500 |
| SA10.BGI0006.00 | 450 | 880 | 1360 |
| SA10.BGI0007.00 | 450 | 1000 | 1500 |
| SA10.BGI0008.00 | 450 | 1340 | 2100 |
| SA10.BGI0010.00 | 475 | 1000 | 1600 |
| SA10.BGI0011.00 | 500 | 1000 | 1650 |
| SA10.BGI0012.00 | 500 | 1120 | 1750 |
| SA10.BGI0014.00 | 550 | 1000 | 1650 |
| SA10.BGI0015.00 | 550 | 1110 | 1750 |
| SA10.BGI0016.00 | 550 | 1200 | 1850 |
| SA10.BGI0017.00 | 550 | 1260 | 2000 |
| SA10.BGI0019.00 | 600 | 1115 | 1800 |
| SA10.BGI0020.00 | 600 | 1200 | 1900 |
| SA10.BGI0021.00 | 600 | 1340 | 2100 |
| SA10.BGI0025.00 | 650 | 1115 | 1800 |
| SA10.BGI0026.00 | 650 | 1200 | 1900 |
| SA10.BGI0027.00 | 650 | 1340 | 2100 |

PARAFANGO 3 ASSI BORDO GOMMA INOX (BGI)

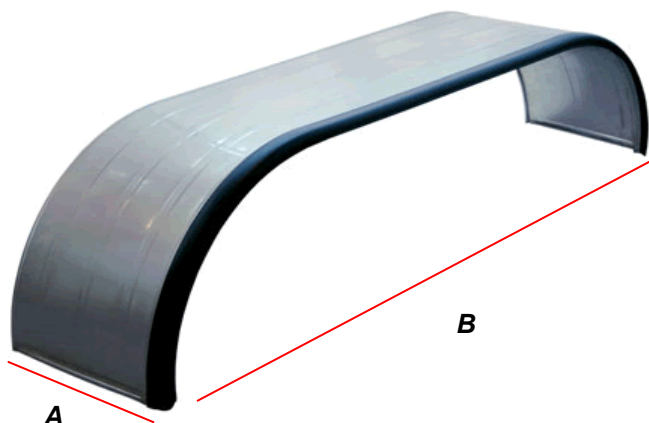

| CODICE | A | B | C |
|-----------------|-----|------|------|
| SA10.BGI0009.00 | 450 | 4100 | 4900 |
| SA10.BGI0013.00 | 500 | 4100 | 4900 |
| SA10.BGI0018.00 | 550 | 2550 | 3300 |
| SA10.BGI0022.00 | 600 | 2500 | 3200 |
| SA10.BGI0023.00 | 600 | 2640 | 3400 |
| SA10.BGI0024.00 | 600 | 2740 | 3500 |
| SA10.BGI0028.00 | 650 | 2740 | 3500 |
| SA10.BGI0029.00 | 650 | 4100 | 4900 |

MEZZO PARAFANGO BORDO GOMMA INOX (BGI)

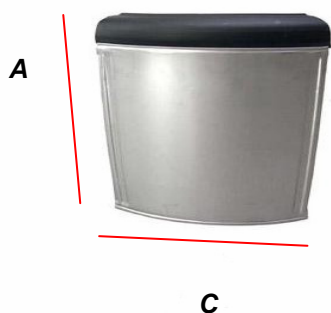

| CODICE | A | C |
|-----------------|----------|----------|
| SA10.BGI0033.00 | 450 | 700 |
| SA10.BGI0034.00 | 450 | 800 |
| SA10.BGI0035.00 | 500 | 800 |
| SA10.BGI0036.00 | 500 | 1000 |
| SA10.BGI0037.00 | 600 | 600 |
| SA10.BGI0038.00 | 600 | 700 |
| SA10.BGI0039.00 | 600 | 800 |
| SA10.BGI0040.00 | 600 | 1000 |
| SA10.BGI0041.00 | 600 | 1200 |
| SA10.BGI0042.00 | 650 | 600 |
| SA10.BGI0043.00 | 650 | 700 |
| SA10.BGI0044.00 | 650 | 800 |
| SA10.BGI0045.00 | 650 | 1000 |
| SA10.BGI0046.00 | 650 | 1200 |

PARAFANGO BORDO GOMMA INOX FIORE (BGIF)

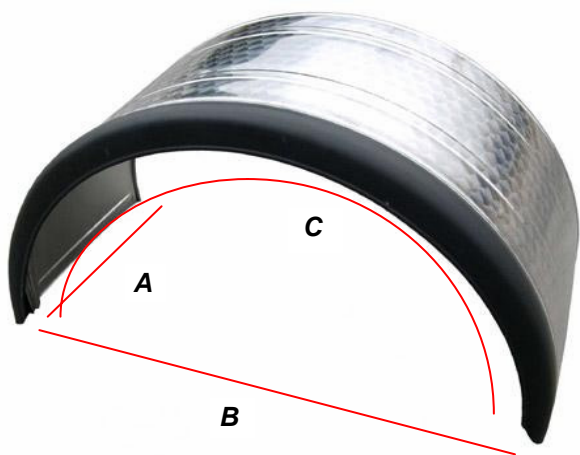

| CODICE | A | B | C |
|-----------------|-----|------|------|
| SA10.BGIF001.00 | 220 | 800 | 1250 |
| SA10.BGIF002.00 | 240 | 900 | 1360 |
| SA10.BGIF003.00 | 280 | 880 | 1360 |
| SA10.BGIF004.00 | 400 | 880 | 1360 |
| SA10.BGIF005.00 | 425 | 1000 | 1500 |
| SA10.BGIF006.00 | 450 | 880 | 1360 |
| SA10.BGIF007.00 | 450 | 1000 | 1500 |
| SA10.BGIF008.00 | 450 | 1340 | 2100 |
| SA10.BGIF010.00 | 475 | 1000 | 1600 |
| SA10.BGIF011.00 | 500 | 1120 | 1750 |
| SA10.BGIF011.01 | 500 | 1000 | 1650 |
| SA10.BGIF011.02 | 500 | 1340 | 2100 |
| SA10.BGIF013.00 | 550 | 1110 | 1750 |
| SA10.BGIF014.00 | 550 | 1200 | 1850 |
| SA10.BGIF016.00 | 600 | 1115 | 1800 |
| SA10.BGIF017.00 | 600 | 1200 | 1900 |
| SA10.BGIF018.00 | 600 | 1340 | 2100 |
| SA10.BGIF022.00 | 650 | 1115 | 1800 |
| SA10.BGIF022.01 | 650 | 1200 | 1900 |
| SA10.BGIF023.00 | 650 | 1340 | 2100 |

PARAFANGO 3 ASSI BORDO GOMMA INOX FIORE (BGIF)

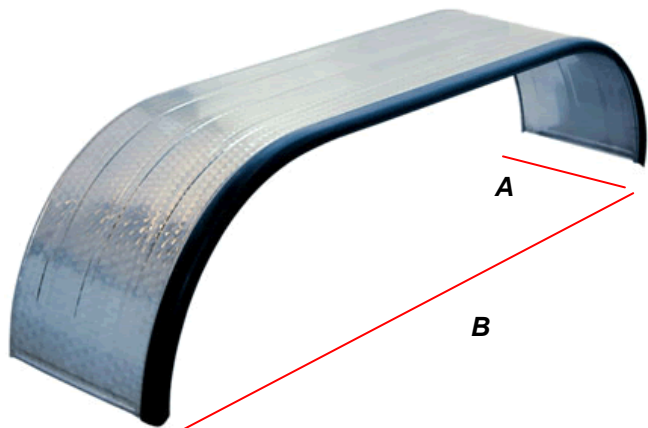

| CODICE | A | B | C |
|-----------------|-----|------|------|
| SA10.BGIF009.00 | 450 | 4100 | 4900 |
| SA10.BGIF012.00 | 500 | 4100 | 4900 |
| SA10.BGIF015.00 | 550 | 2550 | 3300 |
| SA10.BGIF019.00 | 600 | 2500 | 3200 |
| SA10.BGIF020.00 | 600 | 2640 | 3400 |
| SA10.BGIF021.00 | 600 | 2740 | 3500 |
| SA10.BGIF024.00 | 650 | 2640 | 3400 |
| SA10.BGIF025.00 | 650 | 2740 | 3500 |
| SA10.BGIF026.00 | 650 | 4100 | 4900 |

MEZZO PARAFANGO BORDO GOMMA INOX FIORE (BGIF)

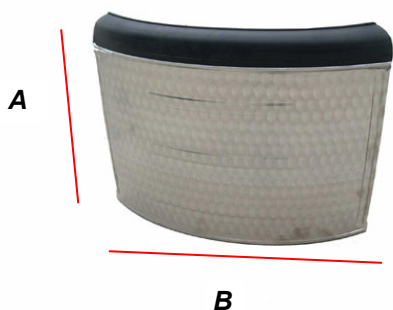

| CODICE | A | C |
|-----------------|----------|----------|
| SA10.BGIF027.00 | 450 | 700 |
| SA10.BGIF028.00 | 450 | 800 |
| SA10.BGIF029.00 | 500 | 700 |
| SA10.BGIF030.00 | 500 | 800 |
| SA10.BGIF031.00 | 500 | 1000 |
| SA10.BGIF032.00 | 600 | 600 |
| SA10.BGIF033.00 | 600 | 700 |
| SA10.BGIF034.00 | 600 | 800 |
| SA10.BGIF035.00 | 600 | 1000 |
| SA10.BGIF036.00 | 600 | 1200 |
| SA10.BGIF037.00 | 650 | 600 |
| SA10.BGIF037.01 | 650 | 650 |
| SA10.BGIF038.00 | 650 | 700 |
| SA10.BGIF039.00 | 650 | 800 |
| SA10.BGIF040.00 | 650 | 1000 |
| SA10.BGIF041.00 | 650 | 1200 |

PARAFANGO LAMIERA NERA 3 ASSI

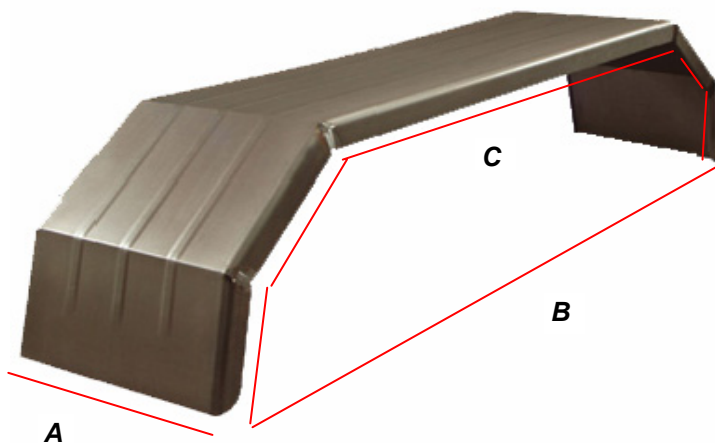

| CODICE | A | B | C |
|----------------|----------|----------|----------|
| SA10.LN0001.00 | 650 | 2740 | 3500 |
| SA10.LN0002.00 | 650 | 1400 | 2300 |

LAMIERA ZINCATA

| CODICE | A | B | C |
|-----------------|----------|----------|----------|
| SA10.LNZ0001.00 | 650 | 2740 | 3500 |

INOX FIORE

| CODICE | A | B | C |
|-----------------|----------|----------|----------|
| SA10.LIF0001.00 | 650 | 2740 | 3500 |

PARAFANGO PVC FLEX-PAR

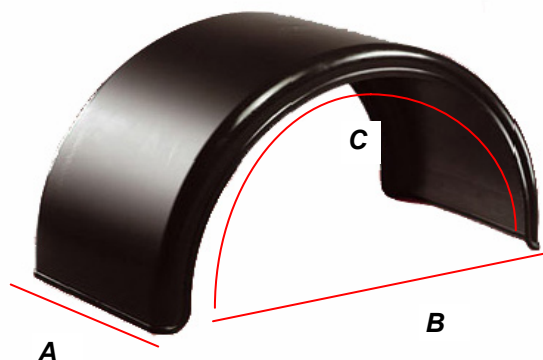

| CODICE | A | B | C |
|-----------------|-----|------|------|
| SA10.PVC0001.00 | 230 | 880 | 1380 |
| SA10.PVC0002.00 | 270 | 880 | 1380 |
| SA10.PVC0003.00 | 400 | 880 | 1380 |
| SA10.PVC0004.00 | 450 | 880 | 1380 |
| SA10.PVC0005.00 | 450 | 1300 | 1900 |
| SA10.PVC0006.00 | 450 | 1340 | 2100 |
| SA10.PVC0007.00 | 500 | 1000 | 1570 |
| SA10.PVC0007.01 | 550 | 1000 | 1600 |
| SA10.PVC0008.00 | 550 | 1150 | 1750 |
| SA10.PVC0009.00 | 600 | 1150 | 1750 |
| SA10.PVC0009.01 | 650 | 1250 | 1900 |
| SA10.PVC0010.00 | 650 | 1300 | 1900 |
| SA10.PVC0011.00 | 650 | 1340 | 2100 |
| SA10.PVC0011.01 | 670 | 2740 | 3400 |

PARAFANGO PVC CON STAFFE REGISTRABILI

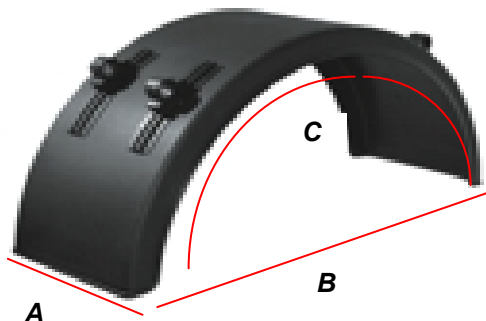

| CODICE | A | B | C |
|-----------------|-----|------|------|
| SA10.PVC0011.02 | 450 | 1300 | 1900 |
| SA10.PVC0011.03 | 450 | 1300 | 2125 |

PARAFANGO PVC CON STAFFE REGISTRABILI



| CODICE | A | B | C |
|-----------------|-----|------|------|
| SA10.PVC0011.01 | 670 | 2740 | 3400 |

PARAFANGO PVC BASE PIATTA

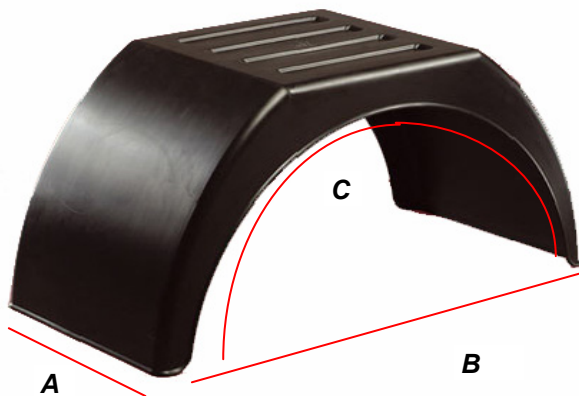

| CODICE | A | B | C |
|-----------------|-----|------|------|
| SA10.PVC0025.00 | 280 | 900 | 1360 |
| SA10.PVC0026.00 | 450 | 910 | 1470 |
| SA10.PVC0027.00 | 500 | 1000 | 1770 |
| SA10.PVC0028.00 | 550 | 1080 | 1870 |

MEZZO PARAFANGO PVC BASE PIATTA

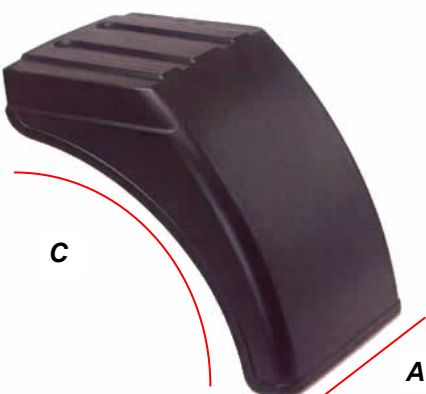

| CODICE | A | C |
|-----------------|-----|-----|
| SA10.PVC0029.00 | 425 | 960 |

MEZZO PARAFANGO PVC C/PORTAGEMMA

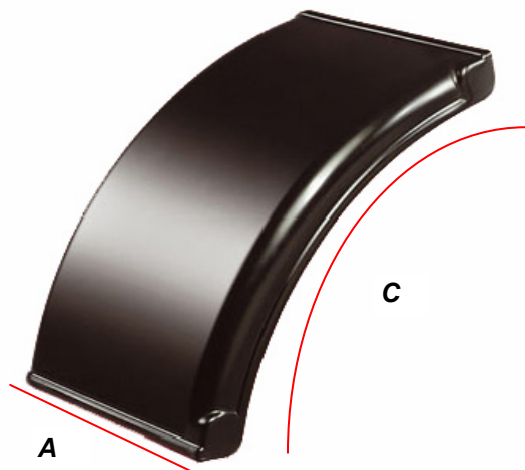

| CODICE | A | C |
|-----------------|-----|-----|
| SA10.PVC0030.00 | 450 | 800 |
| SA10.PVC0031.00 | 650 | 700 |
| SA10.PVC0032.00 | 650 | 800 |

MEZZO PARAFANGO PVC FLEX-PAR

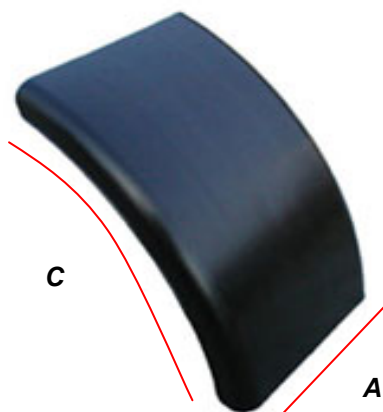

| CODICE | A | C |
|-----------------|-----|-----|
| SA10.PVC0012.00 | 450 | 700 |
| SA10.PVC0013.00 | 450 | 800 |
| SA10.PVC0013.01 | 500 | 500 |
| SA10.PVC0014.00 | 500 | 600 |
| SA10.PVC0015.00 | 500 | 700 |
| SA10.PVC0016.00 | 550 | 500 |
| SA10.PVC0016.01 | 550 | 550 |
| SA10.PVC0017.00 | 550 | 600 |
| SA10.PVC0018.00 | 600 | 600 |
| SA10.PVC0019.00 | 650 | 650 |
| SA10.PVC0020.00 | 650 | 700 |
| SA10.PVC0021.00 | 650 | 800 |

MEZZO PARAFANGO PVC RAIN GUARD

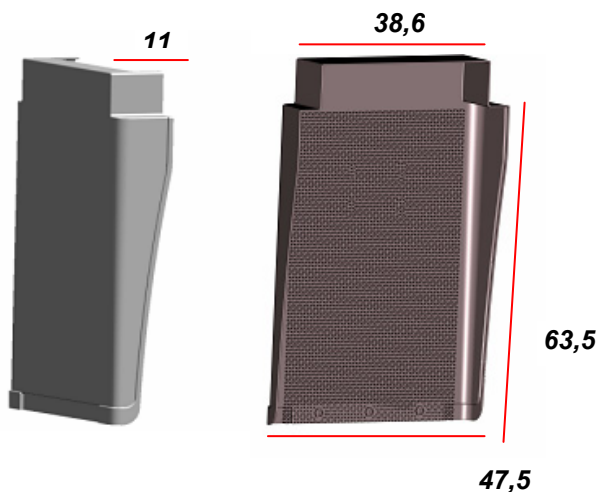

| CODICE | A | C |
|-----------------|---------|-----|
| SA10.PVC0033.00 | 386/475 | 635 |

SUPPORTERIA Ø42



ZINCATO

| CODICE | DESCRIZIONE |
|-----------------|--------------------------|
| SA10.SUP0009.00 | SUPPORTO REG ZINCATO Ø42 |

INOX

| CODICE | DESCRIZIONE |
|-----------------|-----------------------|
| SA10.SUP0017.00 | SUPPORTO REG INOX Ø42 |

SUPPORTO CURVO



ZINCATO

| CODICE | DESCRIZIONE |
|-----------------|--|
| SA10.SUP0014.02 | SUPPORTO ZINC CURVO Ø42 C/VITE cm75 CON STAFFE PVC |
| SA10.SUP0014.03 | SUPPORTO ZINC CURVO Ø42 C/VITE cm75 SENZA STAFFE |

NERO



| CODICE | DESCRIZIONE |
|-----------------|---|
| SA10.SUP0013.00 | SUPP N CURVO C/VITE Ø42 cm75 SENZA STAFFE |
| SA10.SUP0013.01 | SUPP N CURVO C/VITE Ø42 cm59 SENZA STAFFE |
| SA10.SUP0014.00 | SUPP N CURVO C/VITE Ø42 cm75 CON STAFFE PVC |
| SA10.SUP0014.01 | SUPP N CURVO C/VITE Ø42 cm59 CON STAFFE PVC |

SUPPORTI DRITTI



| CODICE | DESCRIZIONE |
|-----------------|------------------------|
| SA10.TUB0002.00 | TUBO ZINCATO Ø42 mm700 |
| SA10.TUB0003.00 | TUBO ZINCATO Ø42 mm800 |

| CODICE | DESCRIZIONE |
|-----------------|----------------------------------|
| SA10.SUP0010.09 | SUPP ZINC DRITTO C/VITE Ø42 cm60 |
| SA10.SUP0011.00 | SUPP ZINC DRITTO C/VITE Ø42 cm70 |
| SA10.SUP0011.01 | SUPP ZINC DRITTO C/VITE Ø42 cm80 |

| CODICE | DESCRIZIONE |
|-----------------|--------------------------------|
| SA10.SUP0013.08 | SUPP Z DR C/FLANGIA 3FORI cm59 |
| SA10.SUP0013.09 | SUPP Z DR C/FLANGIA 3FORI cm69 |
| SA10.SUP0013.10 | SUPP Z DR C/FLANGIA 3FORI cm79 |

SUPPORTI A 90°



| CODICE | DESCRIZIONE |
|-----------------|--------------------------------|
| SA10.SUP0018.00 | SUPP PARACICLI ZINC Ø42 90° AS |

| CODICE | DESCRIZIONE |
|-----------------|--------------------|
| SA10.SUP0008.00 | TAPPO PVC Ø42 |

STAFFE Ø 42



| CODICE | DESCRIZIONE |
|-----------------|--------------------|
| SA10.SUP0003.00 | STAFFA ZINCATA Ø42 |



| CODICE | DESCRIZIONE |
|-----------------|------------------------------------|
| SA10.SUP0004.01 | STAFFA REG ZINC C/NUMERI Ø42 LG |



| CODICE | DESCRIZIONE |
|-----------------|------------------------------|
| SA10.SUP0004.00 | STAFFA REG ZINC C/NUMERI Ø42 |



| CODICE | DESCRIZIONE |
|-----------------|-------------------------------------|
| SA10.SUP0005.00 | STAFFA REG PVC C/NUMERI Ø42 |
| SA10.SUP0006.00 | STAFFA REG PVC C/NUMERI Ø42 cm36 |



| CODICE | DESCRIZIONE |
|-----------------|----------------|
| SA10.SUP0007.00 | STAFFA PVC Ø42 |

ATTACCHI Ø 42



| CODICE | DESCRIZIONE |
|-----------------|---------------------------------|
| SA10.SUP0001.00 | ATTACCO SUPPORTO ZINCATO Ø42 |



| CODICE | DESCRIZIONE |
|-----------------|-----------------------|
| SA10.SUP0002.00 | ATTACCO PVC 3FORI Ø42 |

SUPPORTERIA Ø54

SUPPORTO DRITTO C/STAFFE



ZINCATO

| CODICE | DESCRIZIONE |
|-----------------|----------------------|
| SA10.SUP0020.00 | SUPP REG ZINCATO Ø54 |

INOX

| CODICE | DESCRIZIONE |
|-----------------|--------------------------------|
| SA10.SUP0030.00 | SUPP REG INOX Ø54 ST INOX LISC |
| SA10.SUP0031.00 | SUPP REG INOX Ø54 ST INOX FIOR |

TUBO PIEGATO A 45°



ZINCATO

| CODICE | DESCRIZIONE |
|-----------------|---|
| SA10.SUP0021.01 | TUBO ZINC Ø54 PIEG45° S/STAFFE |
| SA10.SUP0021.00 | SUPP REG ZINC Ø54 PIEG 45° CON STAFFE |
| SA10.SUP0022.00 | SUPP REG ZIN Ø54 PIEG 45° SPESMAGGIORATO CON STAFFE |

INOX

| CODICE | DESCRIZIONE |
|-----------------|--|
| SA10.SUP0032.00 | SUPP REG INOX Ø54 PIEG45° CON STAFFE |
| SA10.SUP0032.01 | SUPP REG INOX Ø54 PIEG45° SENZA STAFFE |

SUPPORTO CENTRALE



ZINCATO

| CODICE | DESCRIZIONE |
|-----------------|---------------------------|
| SA10.SUP0023.00 | SUPP CENTRALE ZINCATO Ø54 |

INOX

| CODICE | DESCRIZIONE |
|-----------------|----------------------------|
| SA10.SUP0033.00 | SUPP REG INOX Ø54 CENTRALE |

SUPPORTI A 90°



| CODICE | DESCRIZIONE |
|-----------------|--------------------------------|
| SA10.SUP0025.00 | SUPP PARACICLI ZINC Ø54 90° TU |



| CODICE | DESCRIZIONE |
|-----------------|--------------------------------|
| SA10.SUP0024.00 | SUPP PARACICLI ZINC Ø54 90° AS |

SUPPORTI PARACICLI



| CODICE | DESCRIZIONE |
|-----------------|-----------------------------------|
| SA10.SUP0025.05 | SUPPORTO PARAC ROV Z cm70 UTLG |



ZINCATO

| CODICE | DESCRIZIONE |
|-----------------|---|
| SA10.SUP0025.01 | SUPPORTO PARACIC ROVESCIBILE ZINC cm55 |
| SA10.SUP0025.02 | SUPPORTO PARACIC ROVESCIBILE ZINC cm70 |

INOX

| CODICE | DESCRIZIONE |
|-----------------|--|
| SA10.SUP0025.03 | SUPPORTO PARAC INOX ROVESCIBILE H75 |



| CODICE | DESCRIZIONE |
|-----------------|---------------|
| SA10.SUP0040.00 | TAPPO PVC Ø54 |

STAFFE Ø 54

ZINCATO



| CODICE | DESCRIZIONE |
|-----------------|--------------------|
| SA10.SUP0039.00 | STAFFA ZINCATA Ø54 |

INOX

| CODICE | DESCRIZIONE |
|-----------------|---------------------------|
| SA10.SUP0035.00 | STAFFA SUPP INOX Ø54 |
| SA10.SUP0036.00 | STAFFA SUPP INOX FIOR Ø54 |

STAFFA PVC FISSA



| CODICE | DESCRIZIONE |
|-----------------|----------------|
| SA10.SUP0037.00 | STAFFA PVC Ø54 |

STAFFA PVC REGISTRABILE



| CODICE | DESCRIZIONE |
|-----------------|--------------------------------|
| SA10.SUP0038.00 | STAFFA PVC REG Ø54 C/NUMERI |

ATTACCHI Ø 54



ZINCATO

| CODICE | DESCRIZIONE |
|-----------------|------------------------------|
| SA10.SUP0043.00 | ATTACCO SUPPORTO ZINCATO Ø54 |

GREZZO

| CODICE | DESCRIZIONE |
|-----------------|-----------------------------|
| SA10.SUP0041.00 | ATTACCO SUPPORTO GREZZO Ø54 |

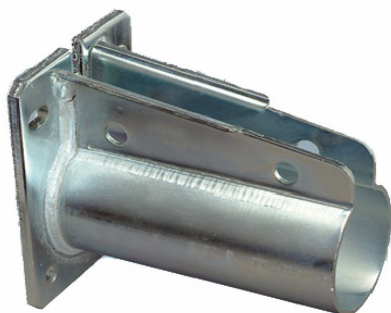

| CODICE | DESCRIZIONE |
|-----------------|--------------------------------------|
| SA10.SUP0045.00 | ATTACCO SUPPORTO ZINCATO MAMMUTH Ø54 |

ZINCATO

| CODICE | DESCRIZIONE |
|-----------------|---|
| SA10.SUP0044.00 | ATTACCO SUPPORTO ZINCATO RINFORZATO Ø54 |



GREZZO

| CODICE | DESCRIZIONE |
|-----------------|--|
| SA10.SUP0041.01 | ATTACCO SUPPORTO GREZZO RINFORZATO Ø54 |



| CODICE | DESCRIZIONE |
|-----------------|--|
| SA10.SUP0042.00 | ATTACCO SUPP RINFORZATO GREZZO Ø54 SENZA FLANGIA |